

SECTION 10 INDEX

The number in brackets indicates page number the product is on

Glynn Johnson

Push/Pull Latch [2]

Keedex

Gate Boxes [2]

Mag

Adapters [19, 10]

Door Silencers [12]

Door Stops [11]

Door Reinforcers [3-5]

Filler Plates [9, 10]

Flush Bolts [12]

Heavy Duty Surface Bolts [12]

Hole Covers [9, 10]

Kick Down Door Holders [12]

Latch Guards [6-8]

Push, Pull and Kick Plates [11]

Security & Dust Proof Strikes [6]

Roton

Continuous Hinges & Options [13, 14]

**Fairway**

DALLAS • HOUSTON • AUSTIN • NASHVILLE

THE SECURITY PROFESSIONAL SUPPLIER

GLYNN-JOHNSON

HL6 PUSH/PULL LATCH

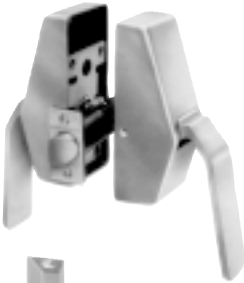

- ▶ Perfect for installation where both versatility and durability are critical
- ▶ Ideal for use on commercial and institutional doors, including fire doors
- ▶ Can be mounted in any of 6 different positions
- ▶ Available in 2³/₄" , 3³/₄" , 5" , or 7" backsets

GLJ HL6-5-26D	Push/Pull Hospital Latch
GLJ HL6-3A-26D	2-3/4" Latch Bolt Only

Finish 26D = Chromium Plated, Dull

MOUNTING POSITIONS

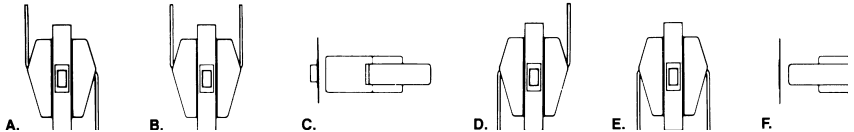

Weldable Gate Boxes

Precision engineered 14 gauge steel

SINGLE LOCK BOXES

KDX KBXSGL	Lock Box 2-3/8" BS, 2-1/8" Hole, 1-1/2" Wide
KDX KBXSGL234	Lock Box 2-3/4" BS, 2-1/8" Hole, 1-1/2" Wide

DOUBLE LOCK BOXES

KDX KBXDBL	Lock Box 2-3/8" BS, 2-1/8" Holes, 1-1/2" Wide
KDX KBXAR	Lock Box for Adams Rite 1850A, 1850S, 1851S, 4511, 4710 & 4711. 1-1/8" BS

MORTISE LOCK BOXES

KDX KBXSIM-1000	Lock Box, Weldable for Simplex/Unican 1000 Series. Alarm Lock Trilogy™ DL2700 (T2) & DL3000 (T3)
KDX KBXSIMEE	Lock Box for the Simplex/Unican EE1000
KDX KBXSIM200	Lock Box for Simplex/Unican 200 Series. Fits models 904, 905, 918 & 919
KDX KBXES2	Electric Strike box for Eff Eff 3314, 4114/4314, 5114/5314 & 7114. Rofu 1402, 1702 & 3402. Adams Rite 7000 & 7040

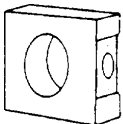

KBXSGL



KBXDBL



KBXAR

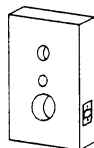

KBXSIM1000

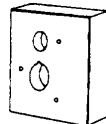

KBXSIM200

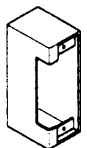

KBXES2



DOOR REINFORCERS STANDARD SERIES (BOXED)

INSTALL-A-LOCK

Door Reinforcement for Deadbolt & Key-in-Knob Locks

All units solid 22 ga. brass, bronze, or stainless steel, fit square on bevel edge doors. Edge prep recessed to accept all standard latches 1" or 1¹/₈" wide x 2¹/₄" high. Latch mounting holes 1⁵/₈" on center & tapped to accept 8-32 machine screws (furnished).

For installing cylindrical door locks with 2" or 2-1¹/₈" bore.
(Strike included).

For 1-3¹/₈" Door

MAG 1AB	Installock 2-3/8" BS, 4" x 9" Overall
MAG 1PB	Installock 2-3/8" BS, 4" x 9" Overall
MAG 1S	Installock 2-3/8" BS, 4" x 9" Overall

For 1-3¹/₄" Door

MAG 2AB	Installock 2-3/8" BS, 4" x 9" Overall
MAG 2PB	Installock 2-3/8" BS, 4" x 9" Overall
MAG 2S	Installock 2-3/8" BS, 4" x 9" Overall
MAG 4AB	Installock 2-3/4" BS, 4.25" x 9" Overall
MAG 4PB	Installock 2-3/4" BS, 4.25" x 9" Overall
MAG 4S	Installock 2-3/4" BS, 4.25" x 9" Overall

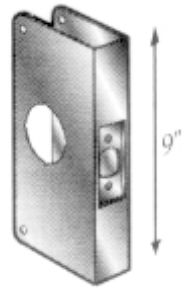

Finishes:

- S:** Stainless Steel
- AB:** Antique Brass
- PB:** Polished Brass

For ADA Lever Locks with 2¹/₈" bore.

For Schlage Rhodes, Arrow Sierra, Corbin Russwin 800, Sargent 10 and Yale 5400LN.



For 1-3¹/₄" Door

MAG 4S-2-32D	InstalLever 2-3/4" BS, 4.75" x 9" Overall
--------------	---

Finish 32D = Stainless Steel

For Standard Deadbolts or Door Locks with 2¹/₈" bore.



For 1-3¹/₈" Door

MAG 51AB	InstalBolt 2-3/8" BS, 4" x 4.5" Overall
MAG 51PB	InstalBolt 2-3/8" BS, 4" x 4.5" Overall

For 1-3¹/₄" Door

MAG 61AB	InstalBolt 2-3/8" BS, 4" x 4.5" Overall
MAG 61PB	InstalBolt 2-3/8" BS, 4" x 4.5" Overall
MAG 61S	InstalBolt 2-3/8" BS, 4" x 4.5" Overall
MAG 81AB	InstalBolt 2-3/4" BS, 4.25" x 4.5" Overall
MAG 81PB	InstalBolt 2-3/4" BS, 4.25" x 4.5" Overall
MAG 81S	InstalBolt 2-3/4" BS, 4.25" x 4.5" Overall

For current pricing, call your Fairway Representative today!

Dallas 800.776.3247 • Houston 800.767.3247 • Austin 877.309.6300 • Nashville 800.815.3247



DOOR REINFORCERS STANDARD SERIES (BOXED)



9" Unit for Key-in-Knob Conversion

For Simplex 1000 Series and Alarm Lock DL-2500.

For 1-3/4" Door

MAG 1000-9S	InstalUnican 2-3/4" BS, 5" x 9" Overall
-------------	---

14" Unit for Mortise Conversion

For Simplex 1000 Series and Alarm Lock DL-2500.

For 1-3/4" Door

MAG 1000-14AB	InstalUnican 2-3/4" BS, 5" x 14" Overall
---------------	--

MAG 1000-14PB	InstalUnican 2-3/4" BS, 5" x 14" Overall
---------------	--

MAG 1000-14S	InstalUnican 2-3/4" BS, 5" x 14" Overall
--------------	--



For Double Locks

With 2 1/8" Top and Bottom Bores, 3-5/8" Between Centers.

For 1-3/4" Door

MAG 261AB	InstalCombo 2-3/8" BS, 4" x 9" Overall
-----------	--

MAG 261PB	InstalCombo 2-3/8" BS, 4" x 9" Overall
-----------	--

Cover Simplex Prep 2-1/8" Bore 4-1/4" from Bottom

For Key-in-Knob.

For 1-3/4" Door

MAG 1004-14AB	Covers Simplex Prep KIK, 2-3/4" BS, 5" x 14" Overall
---------------	--

MAG 1004-14PB	Covers Simplex Prep KIK, 2-3/4" BS, 5" x 14" Overall
---------------	--

MAG 1004-14S	Covers Simplex Prep KIK, 2-3/4" BS, 5" x 14" Overall
--------------	--

Cover Simplex Prep 2-1/8" Bore 4-1/4" from Bottom

For ADA Lever Locks with 2-1/8" Bore for Schlage Rhodes, Arrow Sierra, Corbin Russwin 800, Sargent 10 and Yale 5400LN.

For 1-3/4" Door

MAG 1004-14S2	Covers Simplex Prep KIL, 2-3/4" BS, 5" x 14" Overall
---------------	--

S/32D: Stainless Steel **AB:** Antique Brass **PB/US3:** Polished Brass

For T2 (DL2700) Alarm Lock

For 1-3/4" Door

MAG 1027-14AB	InstalTrilogy, 2-3/4" BS, 5" x 14" Overall
---------------	--

MAG 1027-14PB	InstalTrilogy, 2-3/4" BS, 5" x 14" Overall
---------------	--

MAG 1027-14S	InstalTrilogy, 2-3/4" BS, 5" x 14" Overall
--------------	--

For Mas Hamilton PowerLever Series 3000

For 1-3/4" Door

MAG 3000-14S	Door Reinforcer, 2-3/4" BS, 5" x 14" Overall
--------------	--





DOOR REINFORCERS

Standard Series (Visual Pack Clam Shell)

For Standard Door Locks with 2 1/8" bore.

For 1-3/8" Door

MAG 1-US3	Door Reinforcer 2-3/8" BS, 4" x 9" Overall
-----------	--

For 1-3/4" Door

MAG 2-US3	Door Reinforcer 2-3/8" BS, 4" x 9" Overall
-----------	--

MAG 4-32D	Door Reinforcer 2-3/4" BS, 4.25" x 9" Overall
-----------	---

For Standard Deadbolt or Door Locks With 2 1/8" bore

For 1-3/8" Door

MAG 51-US3	Door Reinforcer 2-3/8" BS, 4" x 4.5" Overall
------------	--

For 1-3/4" Door

MAG 61-US3	Door Reinforcer 2-3/8" BS, 4" x 4.5" Overall
------------	--

S/32D: Stainless Steel **AB:** Antique Brass **PB/US3:** Polished Brass

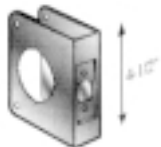

Mortise Series (Boxed)

Blank Channels with Mounting Holes Only

For 1-3/4" Door

MAG 40S	InstalBlank, 4.25" x 9" Overall
---------	---------------------------------

MAG 80PB	InstalBlank, 4.25" x 4.5" Overall
----------	-----------------------------------

MAG 80S	InstalBlank, 4.25" x 4.5" Overall
---------	-----------------------------------

For 1-3/8" Door

MAG 70PB	InstalBlank, 4.25" x 4.5" Overall
----------	-----------------------------------

MAG 70S	InstalBlank, 4.25" x 4.5" Overall
---------	-----------------------------------

Insert for Sectional Trim Cylinder and Knob (for 504 Only) 2 1/4" wide X 6 3/8" high

MAG 500C-S	Insert for 504 Cylinder/Knob
------------	------------------------------

Insert for Sectional Trim Thumb Turn and Knob (for 504 Only) 2 1/4" wide x 6 3/8" high

MAG 500D-S	Insert for 504 Thumbturn/Knob
------------	-------------------------------

For Mortise Locks

1 1/4" x 8" Faceplate with Thru Bolts, Side Prep is 1-7/8" x 6"

For 1-3/4" Door

MAG 504S	InstalMort, 2-3/4" BS, 5" x 12" Overall
----------	---

S/32D: Stainless Steel **AB:** Antique Brass **PB/US3:** Polished Brass

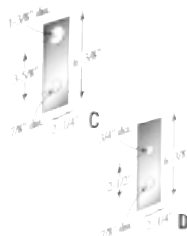

For current pricing, call your Fairway Representative today!

Dallas 800.776.3247 • Houston 800.767.3247 • Austin 877.309.6300 • Nashville 800.815.3247



SECURITY STRIKES



Standard ASA Strike

1-1/4" x 4-7/8" (PolyBagged) with Wood and Machine Screws. 13 GA.

MAG 31B	Strike ASA, Brass
MAG 31C	Strike ASA, Chrome



ASA Mortise Strike

1-1/4" x 4-7/8" (PolyBagged) 25 pcs. per pack.

MAG 32B	Mortise Strike ASA, Brass
MAG 32C	Mortise Strike ASA, Chrome



Large Lip Strike

1-1/4" x 4-7/8" Overall. 2" Long Screws. 18 GA. (Carded).

MAG 721B	Strike ASA, Brass
MAG 721C	Strike ASA, Chrome

Dust Proof Strike

1-3/8" x 2-7/8" (PolyBagged) Includes all mounting screws

MAG 9266	Dust Proof Strike
----------	-------------------

Installation Tool
GROSS V&B 2016

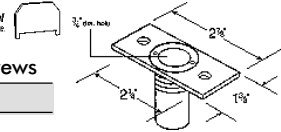

LATCH GUARDS

Latch Guard, 7" for In-Opening Doors

All Backsets, Deadbolts and Key-in-Knob Locks. Reinforces Door and Frame, Prevents Spreading of Frame, Hardened Concealed Screws. (Carded)

MAG 8840C	Latch Guard, Chrome, 5/8" x 7"
MAG 8840DU	Latch Guard, Duronodic, 5/8" x 7"

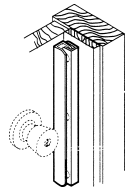

Latch Guard, 12" for In-Opening Doors

All Backsets, Deadbolts and Key-in-Knob Locks. Double Locks, Mortise Locks & Access Control Locks. Reinforces Door and Frame, Prevents Spreading of Frame, Hardened Concealed Screws. (Carded)

MAG 8843C	Latch Guard, Chrome, 5/8" x 12"
-----------	---------------------------------

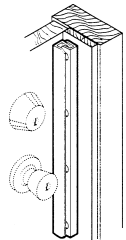

Latch Guard, 6" for Out-Opening Doors

All Backsets, Deadbolts and Key-in-Knob Locks. Protects Latch or Bolt, Heavy Gauge Steel, Accepts up to 3-1/2" Rose. (Carded)

MAG 8845C	Latch Guard, Chrome, 2-1/2" x 6"
-----------	----------------------------------

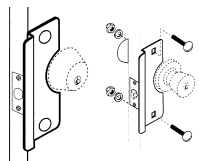



LATCH GUARDS

Latch Guard, Heavy Duty 7" for Out-Opening Doors

All Backsets, Deadbolts and Key-in-Knob Locks. Protects Latch or Bolt, Conceals Lip of Existing Strike Accepts up to 3-1/2" Rose. (Carded)

MAG 8848B HD	Latch Guard, Brass, 3" x 7"
MAG 8848C HD	Latch Guard, Chrome, 3" x 7"
MAG 8848DU	HD Latch Guard, Duronodic, 3" x 7"

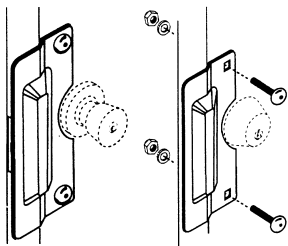

Latch Guard, Universal 11-3/4" for Out-Opening Doors

Single Locks, Double Locks up to 6" on Center, Combination Locks, Mortise Locks & Access Control Locks. Protects Latch or Bolt, Conceals Lip of Existing Strike, Reinforced Mounting Area. (Polybagged)

MAG 8849AL	Latch Guard, Aluminum, 3-1/2" x 11-3/4"
MAG 8849DU	Latch Guard, Duronodic, 3-1/2" x 11-3/4"

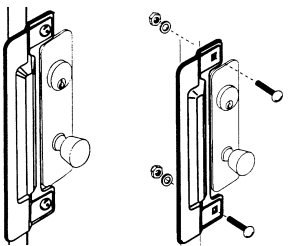

Latch Guard, Universal 11-3/4" for Out-Opening Doors

Single Locks, Double Locks up to 6" on Center, Combination Locks, Mortise Locks & Access Control Locks. Protects Latch or Bolt, Conceals Lip of Existing Strike, Reinforced Mounting Area, **with Anti-Spread Pin.** (Carded)

MAG 8850C	Latch Guard w/Anti Spread Pin, Chrome, 3-1/2" x 11-3/4"
MAG 8850DU	Latch Guard w/Anti Spread Pin, Duronodic, 3-1/2" x 11-3/4"

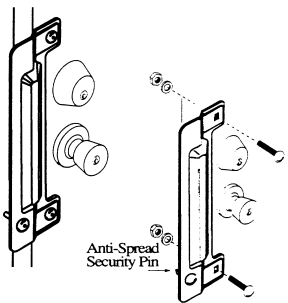

Latch Guard, 11" for Out-Opening Doors

For Mortise or Key-in-Knob Locks. 4 Mounting Bolts Included. (Polybagged)

MAG 8851AL	Latch Guard, Aluminum, 3" x 11"
MAG 8851DU	Latch Guard, Duronodic, 3" x 11"

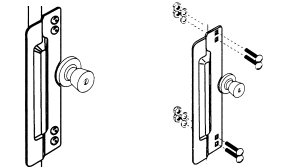

Latch Guard, 6-1/2" for Out-Opening Doors

Narrow Stile, Store Front Doors with Cylinder Guard, and Drive Rivet. (Carded)

MAG 8852AL	Latch Guard Narrow, Aluminum, 3-1/2" x 6-1/2"
MAG 8852DU	Latch Guard Narrow, Duronodic, 3-1/2" x 6-1/2"



For current pricing, call your Fairway Representative today!

Dallas 800.776.3247 • Houston 800.767.3247 • Austin 877.309.6300 • Nashville 800.815.3247



LATCH GUARDS

Latch Guard, 12" for Out-Opening Doors

Narrow Stile, Store Front Doors, Heavy Gauge Steel, 1/4" Offset, 1-1/8" Backset. (Carded)

MAG 8853DU Latch Guard Narrow, Duronodic, 3-1/2" x 12"



Latch Guard, 12" Removable for Flush Doors

Heavy Gauge Steel with Anti Spread Pins, for Single or Double Acting Doors with Cylinder Guard. (Carded)

MAG 8854DU Latch Guard Removable, Duronodic, 3-1/2" x 12"



Angle Latch Guard, 6" for Out-Opening Doors

Key-in-Knob Locks. (Polybagged)

MAG 8857AL Angle Latch Guard, Aluminum, 6"



Angle Latch Guard, 10" for Out-Opening Doors

Mortise Locks. (Polybagged)

MAG 8859AL Angle Latch Guard, Aluminum, 10"



Latch Guard, 4" x 7" for Out-Opening Doors Narrow Stile Doors

Complete with Cylinder Guard and Anti-Spread Pin, Unique Sleeve & Retaining Nut, Allows for Adjustment. (Carded)

MAG 8858AL Latch Guard Narrow, Aluminum, 4" x 7"





HOLE COVERS, ADAPTERS & FILLER PLATES

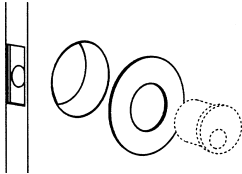

Adapter 2-5/8" Diameter for Rim or Mortise Cylinders

Covers up to 2-1/8" dia. holes, 1-1/4" Inside diameter. (Carded)

MAG 8860C	Adapter Plate, Chrome
-----------	-----------------------

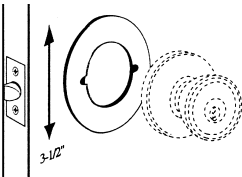

Adapter 2-3/4" Diameter

For Installing Schlage Deadbolts with 1-1/2" Bore in a 2-1/8" Bore. (2 per Card)

MAG 8863B	Adapter Plate, Brass
MAG 8863C	Adapter Plate, Chrome

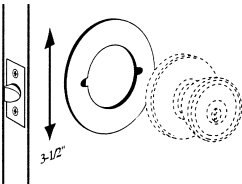

Cover Plates, 3-1/2" Diameter

For 2-1/8" Bore Locks, Covers Damaged Door, Changes 2-3/8" to 2-3/4" Backset, Changes 2-3/4" to 2-3/8" Backset. (2 per Card)

MAG 8865AB	Cover Plate, Ant. Brass
MAG 8865B	Cover Plate, Brass
MAG 8865C	Cover Plate, Chrome
MAG 8865S	Cover Plate, Stainless Steel

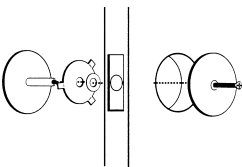

Hole Cover, 2-5/8" Diameter

Cover 1-1/2" to 2-1/8" Holes. Self-Centering Disk Prevents Movement of Plate (Carded)

MAG 8868B	Hole Cover, Brass
MAG 8868C	Hole Cover, Chrome
MAG 8868PC	Hole Cover, Prime Coat

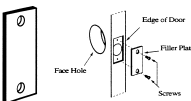

Filler Plate, 1-1/8" x 2-1/4"

For 161 Cutout. (Carded)

MAG 8873PC	Filler Plate for 161, Prime Coat
------------	----------------------------------



Filler Plate, 1-1/4" x 8"

For 86 Mortise Lock Face Cut-Out. (Carded)

MAG 8875PC	Filler Plate for 86 Mortise, Prime Coat
------------	---

For current pricing, call your Fairway Representative today!

Dallas 800.776.3247 • Houston 800.767.3247 • Austin 877.309.6300 • Nashville 800.815.3247



DOOR STOPS

High Dome

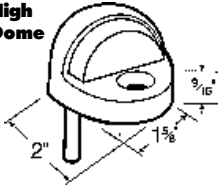

Floor Dome Stops

Solid brass door stops mount to floor. SMS and plastic anchor fasteners.

MAG 9199	9/16" x 1-3/8" High
MAG 9200	3/16" x 1" High

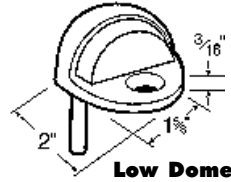

Low Dome

Floor Door Stops

Heavy duty, solid brass door stops mount to floor. Two hole mounting. Polybagged. Fasteners: WS, lead anchor and expansion shield.

MAG 9209	2-1/2" dia., 3" High
----------	----------------------



Wall Door Stops

Concave and convex door stops mount to wall behind door. Includes plastic anchor and plastic drywall anchor.



MAG 9182	2-1/2" dia., 15/16" Projection
----------	--------------------------------

PUSH, PULL AND KICK PLATES

Pull Plates

Solid brass, stainless steel and aluminum pull plates protect doors from marring and damage. 1-3/4" projection. All mounting screws included.

MAG 9042	4" x 16" w/ cast pull
----------	-----------------------



Push Plates

Solid brass, stainless steel and aluminum push plates protect doors from marring and damage. All mounting screws included.

MAG 9032	4" x 16" push plate
----------	---------------------

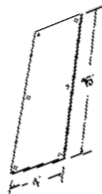

Standard Size

Commercial Kick Plate

Paper wrapped and relieved edges. Shelf pack - 10

MAG 9002	6" x 28"
MAG 9003	6" x 30"
MAG 9004	6" x 32"
MAG 9005	6" x 34"
MAG 9007	8" x 28"
MAG 9008	8" x 30"
MAG 9009	8" x 32"
MAG 9010	8" x 34"
MAG 9012	10" x 28"
MAG 9013	10" x 30"
MAG 9014	10" x 32"
MAG 9015	10" x 34"

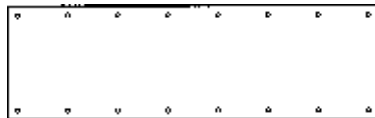

For current pricing, call your Fairway Representative today!

Dallas 800.776.3247 • Houston 800.767.3247 • Austin 877.309.6300 • Nashville 800.815.3247



KICK DOWN DOOR HOLDERS

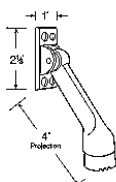

9227-4

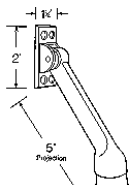

9227-5



9230-GRY



9233-GRY

Solid brass kick down door holder mounts directly to door.

MAG 9227-4	4" Projection
MAG 9227-5	5" Projection
MAG 9230-GRY	Twist On Replacement Tip
MAG 9233-GRY	Screw Held Replacement Tip

HEAVY DUTY SURFACE BOLTS

Solid brass surface mounted door bolts. Includes all mounting screws and multiple strikes.

MAG 9291	8" Long, Square Bolt with Padlock Locking Feature (Padlock Not included)
----------	--

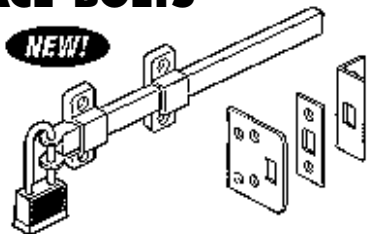

FLUSH BOLTS

Solid brass flush bolts for wood and metal doors. Includes all mounting screws and strike plates.

MAG 9256	1" x 6-3/4" x 12" Rod Length, UL Listed
MAG 9256	1" x 6-3/4" x 7/8" Bolt Throw, UL Listed

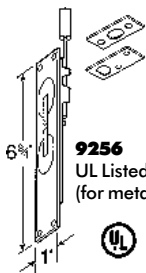

9256

UL Listed (for metal doors)

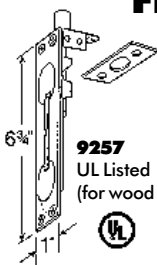

9257

UL Listed (for wood doors)

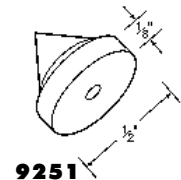

9251

Door Silencers

Rubber door silencers for wood and metal doors. Polybagged.

MAG 9251	Rubber Door Silencer for Metal Doors
MAG 9252	Rubber Door Silencer for Wood Doors

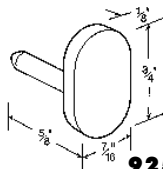

9252



CONTINUOUS GEARED HINGES

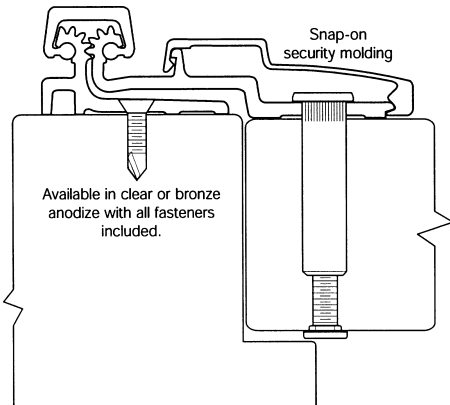

Matchless appearance, extreme durability under high-frequency conditions, rapid installation, the ultimate in security – just a few reasons why Hager's Roton is the "problem solver" of the hardware industry.

The **780-210** is by far the most popular ROTON model for door repairs and retrofit, as it requires no hinge clearance and may be used with doors of virtually any material or thickness. In fact, the geometry of this hinge is designed to allow a door to be literally wedged tight against the hinge jamb, leaving all available clearance for the lock side, prior to the attachment of the door leaf.

Unlike conventional pin-type hinges which have 50% of each leaf cut away to allow for meshing of the knuckles, the ROTON Continuous Hinge has no crosscuts or breaks. The full profile of each extrusion is joined along its entire length, developing extremely high strength-to-weight ratio. Each joint is completely pilfer-proof and sealed against weather.

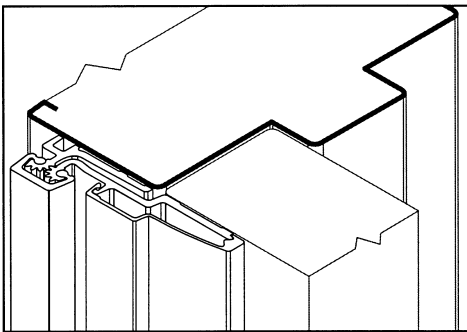

Because the ROTON Continuous Hinge reinforces the entire opening, entrance doors, bruised and battered through constant abuse, are easily repaired even though the frames can no longer hold conventional hardware.

CONTINUOUS HINGE

Full Surface, Retrofit (Heavy Duty), Swing Clear Action.

ROT 780-210HD-CL

ROT 780-057HD

ROT 780-112HD

ROT 780-157HD

ROT 780-210HD

For current pricing, call your Fairway Representative today!

Dallas 800.776.3247 • Houston 800.767.3247 • Austin 877.309.6300 • Nashville 800.815.3247



CONTINUOUS GEARED HINGES OPTIONS

Item	Description	Stock#	Size	Finish
780-053 HD	Half Surface 1 1/4" Doors (Heavy Duty)			
	UM - 1 Each	68814	79"	Clear
		74351	79"	Bronze
		60136	83"	Clear
		60137	83"	Bronze
		79887	85"	Clear
		74989	85"	Bronze
		60935	95"	Clear
		60936	95"	Bronze
		81310	119"	Clear
			119"	Bronze



Item	Description	Stock#	Size	Finish
780-112 HD	Concealed Leaf, Entry Door (Heavy Duty) 1 1/4" Doors, Templated			
	UM - 1 Each	60102	79"	Clear
		60106	79"	Bronze
		60103	83"	Clear
		60107	83"	Bronze
		60771	85"	Clear
		60756	85"	Bronze
		60104	95"	Clear
		60108	95"	Bronze
		60105	119"	Clear
		60109	119"	Bronze



Item	Description	Stock#	Size	Finish
780-210 HD	Full Surface, Retrofit (Heavy Duty) <u>Swing Clear Action</u>			
	UM - 1 Each	60072	79"	Clear
		60076	79"	Bronze
		60073	83"	Clear
		60077	83"	Bronze
		61345	85"	Clear
		61418	85"	Bronze
		60074	95"	Clear
		60078	95"	Bronze
		60075	119"	Clear
		60079	119"	Bronze

